

AMAFI-110&AMAFI-162

Einbauverkleidung



Einbau Trimless



Festgelegter Typ



AMAFI 110-STF
AMAFI 162-STF



AMAFI 110-RTF
AMAFI 162-RTF



Festgelegter Typ



AMAFI 110-STLF



AMAFI 110-RTLF



Verstellbarer Typ



AMAFI 110-STW
AMAFI 162-STW



AMAFI 110-RTW
AMAFI 162-RTW



Verstellbarer Typ



AMAFI 110-STLW



AMAFI 110-RTLW

Verschiedenste Kombinationsmöglichkeiten



Montagediagramm für randloses Downlight:

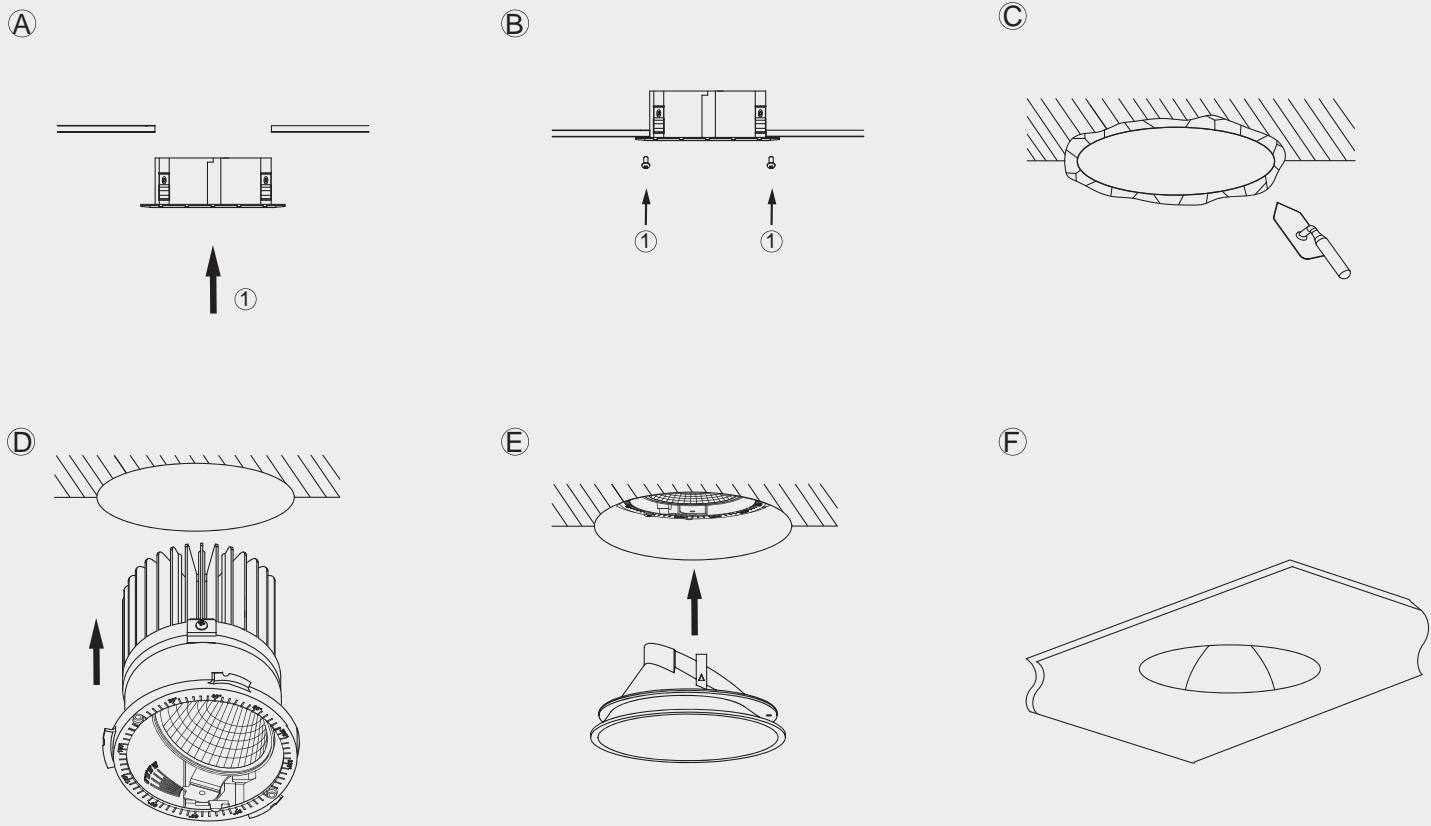



Article number	1718.169
LED Consumption	25.5W
Current	700 (mA)
Lumen	2670 (lm)
Beam Angle	15°/25°/38° (Lens)
CCT	3000K
CRI	90+

Color available :

Bezel :  
 Black White

Baffle :   
 Black White Matt chrome



Dimmable

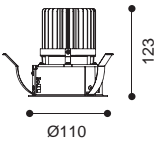

1718.169(25.5W)

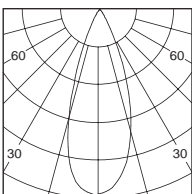
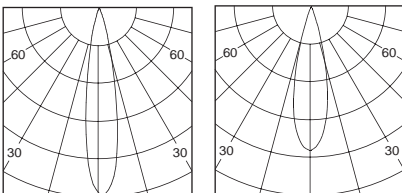

Article number	1718.193
LED Consumption	25.5W
Current	700 (mA)
Lumen	2670 (lm)
Beam Angle	15°/25°/38° (Lens)
CCT	3000K
CRI	90+

Color available :

Bezel :  
 Black White

Baffle :   
 Black White Matt chrome



Dimmable

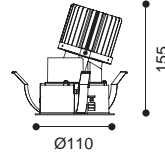



Article number	1718.170
LED Consumption	25.5W
Current	700 (mA)
Lumen	2670 (lm)
Beam Angle	15°/25°/38° (Lens)
CCT	3000K
CRI	90+

Color available :

Baffle :   
 Black White Matt chrome



Dimmable

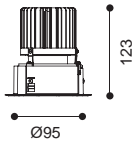

1718.170(25.7W)

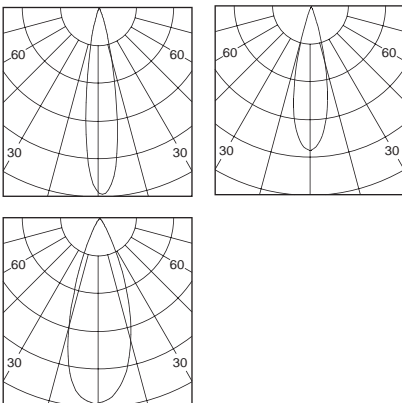

Article number	1718.228
LED Consumption	25.5W
Current	700 (mA)
Lumen	2670 (lm)
Beam Angle	15°/25°/38° (Lens)
CCT	3000K
CRI	90+

Color available :

Baffle :   
 Black White Matt chrome



Dimmable

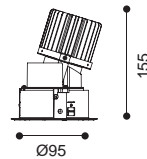



Article number	1718.171
LED Consumption	25.5W
Current	700 (mA)
Lumen	2670 (lm)
Beam Angle	15°/25°/38°(Lens)
CCT	3000K
CRI	90+

Color available :

Bezel :  
Black White

Baffle :   
Black White Matt chrome



Dimmable

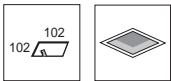
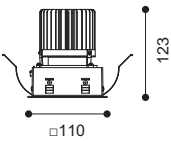

1718.171(25.5W)

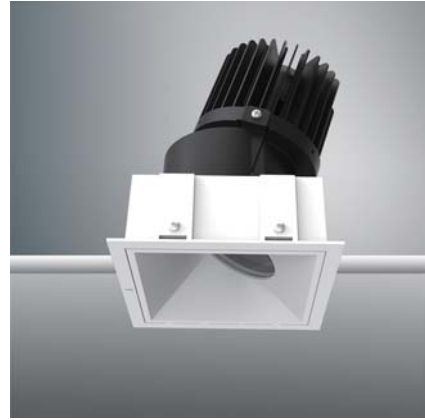
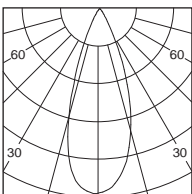
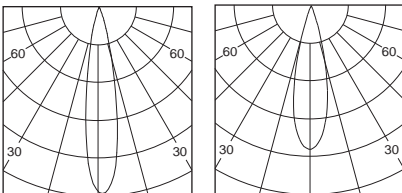

Article number	1718.194
LED Consumption	25.5W
Current	700 (mA)
Lumen	2670 (lm)
Beam Angle	15°/25°/38° (Lens)
CCT	3000K
CRI	90+

Color available :

Bezel :  
Black White

Baffle :   
Black White Matt chrome

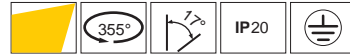

Dimmable

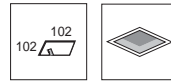
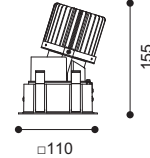



Article number	1718.172
LED Consumption	25.5W
Current	700 (mA)
Lumen	2670 (lm)
Beam Angle	15°/25°/38°(Lens)
CCT	3000K
CRI	90+

Color available :

Baffle :   
 Black White Matt chrome



Dimmable

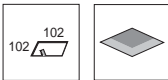
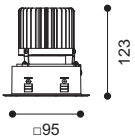

1718.172(25.5W)

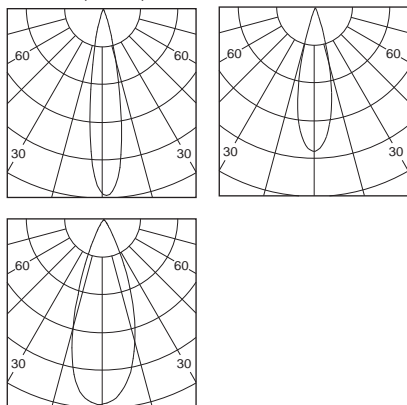

Article number	1718.229
LED Consumption	25.5W
Current	700 (mA)
Lumen	2670 (lm)
Beam Angle	15°/25°/38° (Lens)
CCT	3000K
CRI	90+

Color available :

Baffle :   
 Black White Matt chrome

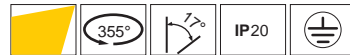

Dimmable

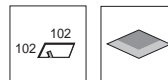
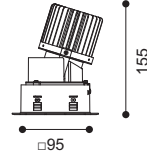



Article number	1718.174
LED Consumption	39.1W
Current	1050 (mA)
Lumen	4058 (lm)
Beam Angle	18°/28°/38°(Lens)
CCT	3000K
CRI	90+

Color available :

Bezel : Black White

Baffle : Black White Matt chrome



Dimmable

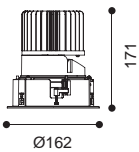

Article number	1718.191
LED Consumption	39.1W
Current	1050 (mA)
Lumen	4058 (lm)
Beam Angle	18°/28°/38°(Lens)
CCT	3000K
CRI	90+

Color available :

Bezel : Black White

Baffle : Black White Matt chrome

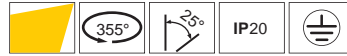

Dimmable

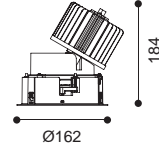



Article number	1718.175
LED Consumption	39.1W
Current	1050 (mA)
Lumen	4058 (lm)
Beam Angle	18°/28°/38°(Lens)
CCT	3000K
CRI	90+

Color available :

Bezel :  
 Black White

Baffle :   
 Black White Matt chrome



Dimmable

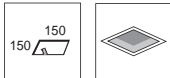
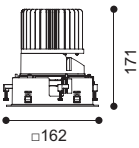

Article number	1718.192
LED Consumption	39.1W
Current	1050 (mA)
Lumen	4058 (lm)
Beam Angle	18°/28°/38°(Lens)
CCT	3000K
CRI	90+

Color available :

Bezel :  
 Black White

Baffle :   
 Black White Matt chrome



Dimmable

